

mikado

design f.a. porsche



mikado track



mikado pendelleuchte



mikado halbeinbau



mikado wandleuchte/deckenleuchte

mikado track

design f.a. porsche

Stromschienenprofile aus Aluminium
in schwarz oder grau eloxiert.
Transformator von 230 V-12 V mit Kapazität
bis 25A.

strahler

Verstellbare Niedervolt-Strahler aus
Aluminiumguss, metallgrau lackiert,
komplett mit Adapter.
Verfügbar in den Gesamtpendellängen
130, 155, 300 und 600 mm.

lichtquellen

12 V Multi-Mirror Halogenlampen.
12 V NV-Halogenlampen.

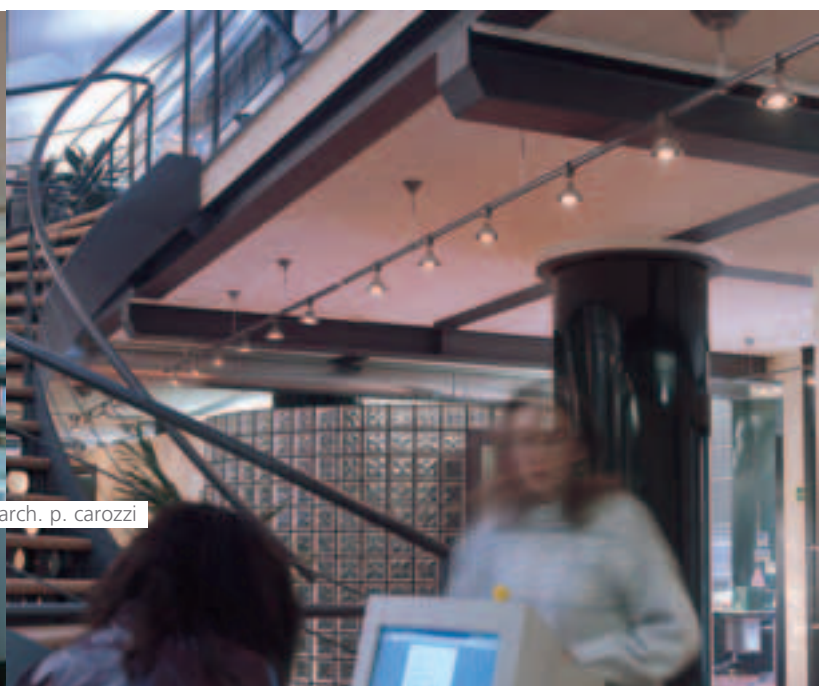
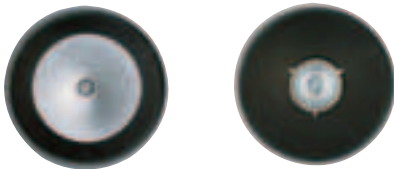

s.m.a., milano (I), arch. p. carozzi

mikado track

design f.a. porsche

mikado track Ø120

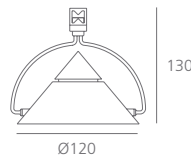

IP 20
metallgrau

H m	Ø m	EMax lux	EM lux
1	0,26	3399	2074
2	0,54	850	519
3	0,80	378	230
4	1,06	212	130
5	1,40	136	83

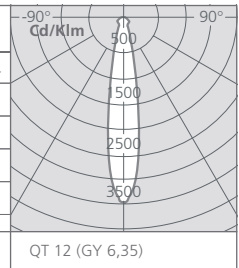

Ausstrahlungswinkel 2x8°

QT 12 (GY 6,35)

	QT 12 (GY 6,35)	QR-CBC 51 (GU 5,3)	gewicht kg
Strahler für Multi-Mirror Halogenlampe mit Adapter.	L155700	12 V 1xmax50 W	0,22
	L155600	12 V 1xmax50 W	0,21

mikado track Ø160

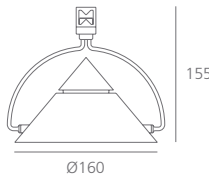
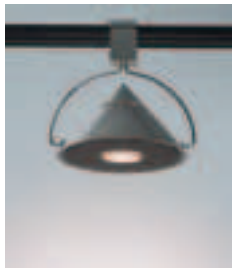

IP 20
metallgrau

QR-CBC 51 (GU 5,3)

gewicht
kg

Strahler für Multi-Mirror Halogenlampe mit Adapter.	L155800	12 V 1xmax50 W	0,33
---	----------------	----------------	------

mikado track Ø120

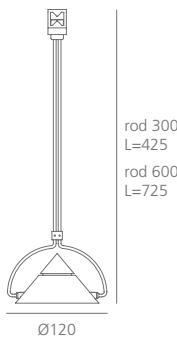

IP 20
metallgrau

QR-CBC 51 (GU 5,3)

pendellänge
mm

gewicht
kg

Strahler für Multi-Mirror Halogenlampe mit Adapter.	L156300	12 V 1xmax50 W	300	0,23
	L157100	12 V 1xmax50 W	600	0,34

mikado track

design f.a. porsche

mikado track Ø160

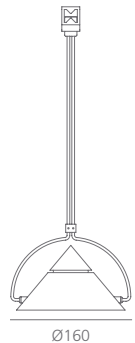

rod 300
L=445
rod 600
L=745

Ø160

IP 20
metallgrau

		QR-CBC 51 (GU 5,3)	pendellänge mm	gewicht kg
Strahler für Multi-Mirror Halogenlampe mit Adapter.	L156500	12 V max50 W	300	0,40
	L157300	12 V max50 W	600	0,46

komponenten

	pendelaufhängung	linearer verbinder mit pendelaufhängung	pendelaufhängung mit einspeisung	länge mm
			L157600	100
	L155100	L154400	L154800	300
	L155200	L154500	L154900	600
	L155300	L154600	L155000	1200

	350/ 650/ 1250		360/ 660/ 1260		150/ 350/ 650/ 1250
--	----------------------	--	----------------------	--	------------------------------

Stromschiene track.		schwarz 30, grau 90		
	länge mm	gewicht kg		
	L1540..	1000	0,40	
	L1541..	2000	0,90	
	L1542..	3000	1,40	

Endkappe; 2 Stücke.		gewicht kg	
L154300		0,02	

Ringkerntransformator; 230/12 V.		gewicht kg	
	VA	gewicht kg	
L460173	300	3,00	

Verbinder ohne Pendelaufhängung (linear).		gewicht kg	
L154700		0,09	

Verbinder ohne Pendelaufhängung (flexibel).		gewicht kg	
L153700		0,10	

Transformatorgehäuse.		Ø mm	VA	gewicht kg
	L159900	235	300	0,83
	L155400	300	500	1,03

Einspeisungsrosette.		gewicht kg	
L154600	185	0,29	

mikado pendelleuchte

design f.a. porsche

auszeichnung "haus industrieform", 1988 (D)

Pendelleuchten in der Höhe verstellbare aus Aluminiumguss, Metallgrau lackiert.

lichtquellen

12 V Multi-Mirror Halogenlampen.

lichtverteilung

Spot.



mikado pendelleuchte

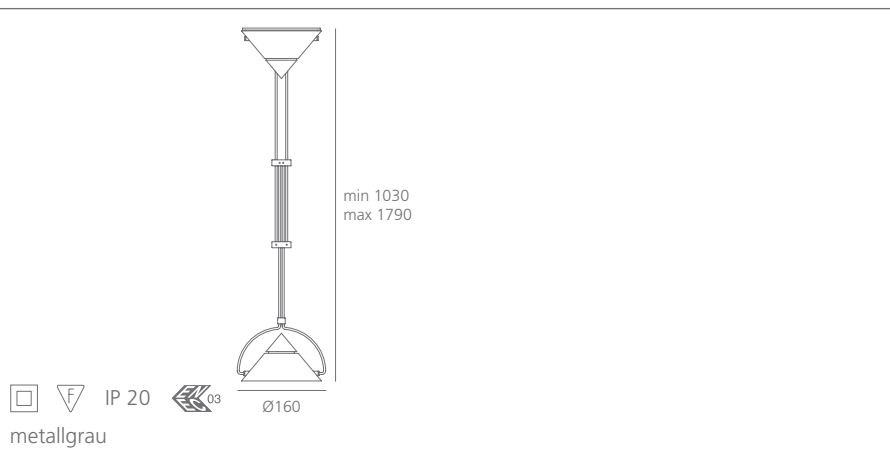

metallgrau

QR-CBC 51
(GU 5,3)

pendellänge
mm

gewicht
kg

Pendelleuchte für Multi-Mirror Halogenlampe.
Mit Pendellänge von 600 bis 900 mm
höhenverstellbar und
integriertem Ringkerntransformator.

L144800

12 V 1xmax50 W

600 - 900

1,44

L145200

12 V 1xmax50 W

1030 - 1790

1,62

mikado wandleuchte / deckenleuchte

design f.a. porsche

auszeichnung "haus industrieform", 1988 (D)

Verstellbare Decken- oder Wand- Niedervolt-
Leuchten aus Aluminiumguss, metallgrau lackiert.

lichtquellen

12 V Multi-Mirror Halogenlampen.
12 V NV-Halogenlampen.



mikado wandleuchte / deckenleuchte Ø120

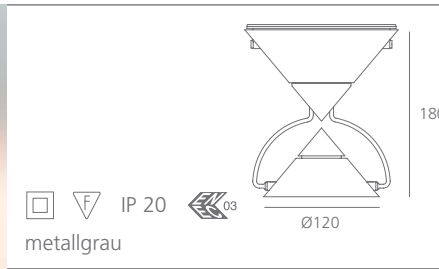

H m	Ø m	EMax lux	EM lux	Cd/Klm
1	0,26	3399	2074	900
2	0,54	850	519	1500
3	0,80	378	230	2500
4	1,06	212	130	3500
5	1,40	136	83	

Ausstrahlungswinkel 2x8°

QT 12 (GY 6,35)

	QT 12 (GY 6,35)	QR-CBC 51 (GU 5,3)	gewicht kg
Wand / Deckenleuchte für NV-Halogenlampe mit integriertem Ringkerntransformator.	L142300	12 V 1xmax50 W	1,80
Wand / Deckenleuchte für Multi-Mirror Halogenlampe mit integriertem Ringkerntransformator.	L142400	12 V 1xmax50 W	1,08

mikado wandleuchte / deckenleuchte Ø160

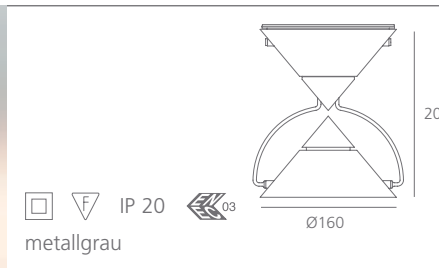

H m	Ø m	EMax lux	EM lux	Cd/Klm
1	0,42	1834	1134	375
2	0,84	458	283	1125
3	1,26	204	126	1875
4	1,68	115	71	3500
5	2,10	73	45	

Ausstrahlungswinkel 2x12°

QT 12 (GY 6,35)

	QT 12 (GY 6,35)	QR-CBC 51 (GU 5,3)	gewicht kg
Wand- Deckenleuchte für NV-Halogenlampe mit integriertem Ringkerntransformator.	L141700	12 V 1xmax50 W	1,18
Wand- Deckenleuchte für Multi-Mirror Halogenlampe mit integriertem Ringkerntransformator.	L141900	12 V 1xmax50 W	1,20

mikado halbeinbau

design f.a. porsche

Verstellbare Niedervolt-HalbeinbauStrahler
aus Aluminiumguss, metallgrau lackiert.

lichtquellen

12 V Multi-Mirror Halogenlampen.



mikado halbeinbau Ø120

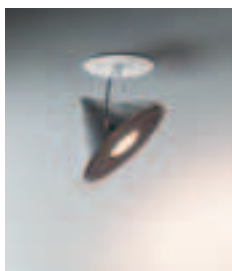

□ ▽ IP 20 
metallgrau

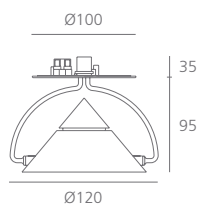

QR-CBC 51 
(GU 5,3)

gewicht
kg

Strahler für Multi-Mirror Halogenlampe.

L152300

12V 1xmax50W

1,80

mikado halbeinbau Ø160



□ ▽ IP 20 
metallgrau

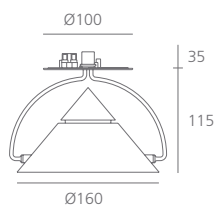

QR-CBC 51 
(GU 5,3)

gewicht
kg

Strahler für Multi-Mirror Halogenlampe.

L152700

12 V 1xmax71W

0,36